

T

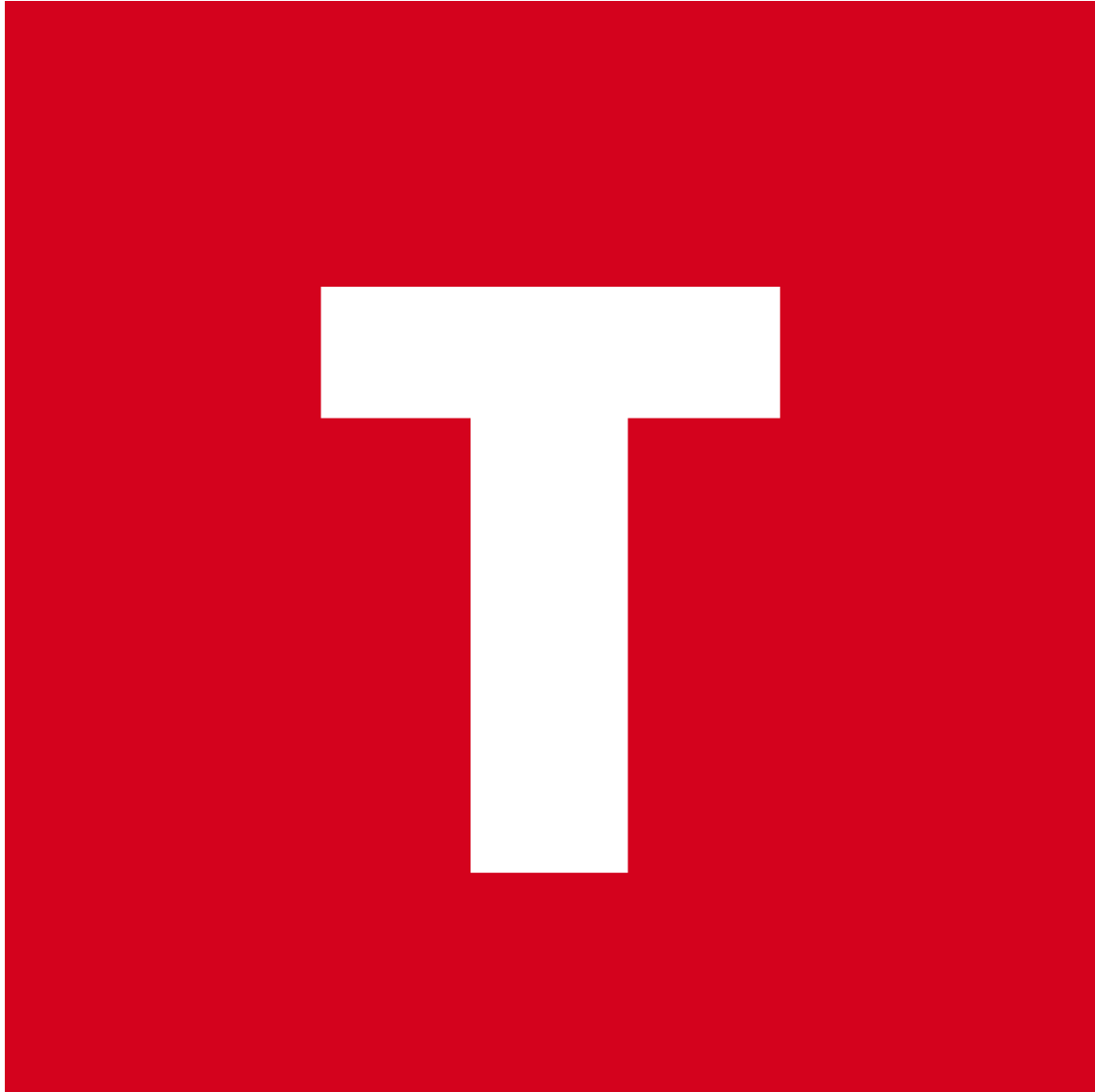

Technical Information

CONVERSION TABLE FOR UNITS OF PRESSURE

	bar	mbar	Pa (N/m ²)	kPa (kN/m ²)	Torr mmHg (0 °C)	mWs (4 °C)	at kp/cm ²	inch Hg (0 °C)	inch H ₂ O (4 °C)	PSI lb/inch ²	atm
bar	1	1000	100000	100	750.062	10.1972	1.01972	29.53	401.463	14.5038	0.986923
mbar	0.001	1	100	0.1	0.750062	0.0101972	0.00101972	0.02953	0.401463	0.014504	0.000986923
Pa (N/m ²)	0.00001	0.01	1	0.001	0.007501		1.01972 x 10 ⁻⁵	0.0002953	0.004015	0.000145038	9.86923 x 10 ⁶
kPa (kN/m ²)	0.01	10	1000	1	7.501	0.10197	0.010197	0.2953	4.015	0.145038	0.00986923
Torr mmHg (0 °C)	0.00133322	1.33322	133.322	0.133322	1	0.0135951	0.00135951	0.03937	0.53524	0.019337	0.00131579
mWs (4 °C)	0.098067	98.0665	9806.65	9.80665	73.5559	1	0.1	2.8959	39.3701	1.42233	0.096784
at kp/cm ²	0.980665	980.665	98066.5	98.0665	735.559	10	1	28.959	393.701	14.2233	0.967841
inch Hg (0 °C)	0.033864	33.8639	3386	3.386	25.4	0.345316	0.034532	1	13.5951	0.491154	0.033421
inch H ₂ O (4 °C)	0.00249089	2.49089	249.089	0.249089	1.86832	0.0254	0.00254	0.073556	1	0.03613	0.002458
PSI lb/inch ²	0.06895	68.9476	6894.76	6.89476	51.7149	0.70307	0.070307	2.03602	27.68	1	0.068046
atm	1.01325	1013.25	101325	101.325	760	10.3323	1.03323	29.921	406.78	14.6959	1

CONVERSION TABLE FOR TEMPERATURES

Fahrenheit [°F]	Celsius [°C]
-40	-40
-35	-37.2
-30	-34.4
-25	-31.7
-20	-28.9
-15	-26.1
-10	-23.3
-5	-20.6
0	-17.8
5	-15.01
10	-12.2
15	-9.4
20	-6.7
25	-3.9
30	-1.1
32	0
35	1.7

Fahrenheit [°F]	Celsius [°C]
40	4.4
45	7.2
50	10.0
55	12.8
60	15.6
65	18.3
70	21.1
75	23.9
80	26.7
85	29.4
90	32.2
95	35.0
100	37.8
105	40.6
110	43.3
115	46.1
120	48.9

Fahrenheit [°F]	Celsius [°C]
125	51.7
130	54.4
135	57.2
140	60.0
145	62.8
150	65.6
155	68.3
160	71.1
165	73.9
170	76.7
175	79.4
180	82.2
185	85.0
190	87.8
195	90.6
200	93.3

THREADS AND THEIR DIMENSIONS

Thread ISO 228

Whitworth pipe thread BSP (British Standard Pipe)

Pipe threads where pressure-tight joints are not made on the threads (cylindrical)

Designation	Diameter	Diameter External	Diameter Nut:	Diameter Core hole	Threads per inch	Pitch
	[Inch]	mm	mm	mm		
G 1/8"	1/8	9.73	8.85	8.80	28	0.907
G 1/4"	1/4	13.16	11.89	11.80	19	1.337
G 3/8"	3/8	16.66	15.39	15.25	19	1.337
G 1/2"	1/2	20.95	19.17	19.00	14	1.814
G 5/8"	5/8	22.91	21.13	21.00	14	1.814
G 3/4"	3/4	26.44	24.66	24.50	14	1.814
G 1"	1	33.25	30.93	30.75	11	2.309
G 1 1/4"	1 1/4	41.91	39.59	39.25	11	2.309
G 1 1/2"	1 1/2	47.8	45.48	45.25	11	2.309
G 2"	2	59.61	57.29	57.00	11	2.309
G 2 1/2"	2 1/2	75.18	72.86	72.60	11	2.309
G 3"	3	87.88	85.56	85.30	11	2.309
G 3 1/2"	3 1/2	100.33	98.01	97.70	11	2.309
G 4"	4	113.03	110.71	110.40	11	2.309

Thread ISO 7/1

Whitworth tapered pipe thread BSPT (British Standard Pipe Tapered)

Cylindrical internal thread and conical (cone 1:16) external thread

Designation External	Designation Internal	Nominal diameter	Diameter External	Diameter Core hole	Threads per inch	Pitch
		mm	mm	mm		
R 1/8"	Rp 1/8"	6	9.728	8.566	28	0.907
R 1/4"	Rp 1/4"	8	13.157	11.445	19	1.337
R 3/8"	Rp 3/8"	10	16.662	14.95	19	1.337
R 1/2"	Rp 1/2"	15	20.995	18.631	14	1.814
R 3/4"	Rp 3/4"	20	26.441	24.117	14	1.814
R 1"	Rp 1"	25	33.249	30.291	11	2.309
R 1 1/4"	Rp 1 1/4"	32	41.91	38.952	11	2.309
R 1 1/2"	Rp 1 1/2"	40	47.803	44.845	11	2.309
R 2"	Rp 2"	50	59.614	56.656	11	2.309
R 2 1/2"	Rp 2 1/2"	65	75.184	72.226	11	2.309
R 3"	Rp 3"	80	87.884	84.926	11	2.309
R 4"	Rp 4"	100	113.03	110.072	11	2.309

SEAL MATERIALS

Acronym	Description	Registered trademark	Application	Temperature	Item groups
NBR	Acrylonitrile-butadiene rubber	Perbunan®	In hydraulics and pneumatics, resistant to hydraulic oils, water-glycol mixtures and oil-in-water emulsions, mineral oils and mineral oil products, animal and plant oils, petrol, heating oil, water up to approx. 70 °C, air up to 80 °C	-30 °C to +80 °C	Maintenance units Cylinders and control valves Fittings / connectors
FKM FPM	Fluoro rubber Fluorocarbon rubber	Viton®	FPM provides excellent resistance to high temperatures, ozone, oxygen, mineral oils, synthetic hydraulic liquids, fuels, aromatics, many organic solvents and chemicals. The material's gas permeability is low and similar to that of butyl rubber.	-25 °C to +200 °C	Valves and isolation fittings Couplings Fittings / connectors Cylinders and control valves
EPDM	Ethylene-propylene diene monomer rubber		Steam up to 200 °C, hot water, air up to 150 °C, dilute acids, not resistant to mineral oil products	+200 °C	Non-return valves (Please enquire) Couplings (Please enquire)
CR	Polychloroprene rubber, chlorinated rubber	Neoprene®	Resistant to silicone oils and greases, refrigerants, better ozone resistance, weather resistance and aging resistance compared to NBR	-40 °C to +100 °C	Solenoid valves
PTFE	Polytetrafluoroethylene	Teflon®	Resistant to almost all organic and inorganic chemicals (except elemental fluorine under pressure or at high temperatures, fluoro-halogen compounds and alkali metal fusions). - Excellent anti-adhesive behaviour - No water absorption (< 0.01 %) - Low thermal conductivity	-200 °C to +260 °C	Valves and isolation fittings

MATERIALS AND THEIR FIELDS OF USE

Stainless steel			
Materials	Chemical designation	AISI	Applications
1.4301	X5CrNi18-10	AISI 304	Apparatus and components for the chemical industry, textile industry, cellulose production, dye works and in the photographic, paint, artificial resin and rubber industries
1.4305	X10CrNiS18-9	AISI 303	Turned parts for the food and dairy industries, photographic, paint, oil, soap, paper and textile industries
1.4401	X5CrNiMo17-12-2	AISI 316	Parts and apparatus in the cellulose, rayon, textile, oil and artificial silk industries, dairies, breweries
1.4404	X2CrNiMo17-12-2	AISI 316 L	Parts and apparatus in the cellulose, rayon, textile, oil and artificial silk industries, dairies, breweries. Use as casting material for precision cast fittings
1.4408	G-X6CrNiMo18-10	Similar to AISI 316	Material for precision cast fittings
1.4571	X6CrNiMoTi17-12-2	AISI 316Ti	Apparatus and components for the chemical industry, textile industry, cellulose production, dye works and in the photographic, paint, artificial resin and rubber industries
Brass			
Material	Chemical designation	Applications	
2.0331	CuZn39Pb2	<ul style="list-style-type: none"> Sanitary valves, fittings, bolts, nuts Drop-forged parts, stampings, gear wheels, gear racks Parts for security locks in vehicles, keys Clock housings, clock mechanisms, spring housings, date rings Screw terminals Perforated plates (for the paper industry) Signs, metal letters, rivet parts 	

AIR TREATMENT / FILTERING

Compressed air should always be clean enough to ensure that it causes no malfunctions and **no damage** to the components. Dirt causes higher wear and detrimentally affects the service life of the pneumatic elements. Any filter in the system will create a flow resistance, therefore, on economic grounds, the **filtration efficiency** should be matched to the **requirements of the application** – the air should be as clean as necessary.

ISO 8573-1 defines **different purity classes** to allow a consistent assessment of cleaning efficiency to be made. Different requirements apply to the quality of compressed air, depending on the needs of the application. The quality classes should therefore include the following information as per the ordered list below:

1. Quality class for particles
2. Quality class for water
3. Quality class for total oil (droplets, aerosols, vapours)

Class	Solids	Water content	Oil content
	Max. particle size [µm]	Pressure dew point [°C]	Max. oil concentration [mg/m³]
1	0.1	-70	0.01
2	1	-40	0.1
3	5	-20	1
4	15	+3	5
5	40	+7	25

VACUUM

Vacuum is expressed in relation to absolute pressure (absolute zero point).
 Designation: - value (negative pressure value) in per cent (%) in the range of 0...1 bar absolute pressure

APPLICATION IN THE FIELD OF COARSE OR OPERATIVE VACUUM AT HANSA-FLEX

Vacuum expressed as a relative value in relation to **average atmospheric ambient pressure** (approx. 1000 mbar). The vacuum value has a **preceding negative sign**, because the **atmospheric ambient pressure** is taken as the **zero point**. This means that the **lowest possible value** is -1 bar or 100 % vacuum.

Unit	Levels of vacuum			
	Coarse vacuum	Fine vacuum	High vacuum	Ultra-high vacuum
mbar	10 ³ to 1	1 to 10 ⁻³	10 ⁻³ to 10 ⁻⁷	< 10 ⁻⁷

SOLENOID VALVES

Solenoid valves 2/2-3/2-way directional media valves and their methods of actuation:

Directly actuated valve	
Description	Intrinsic features
In a directly actuated valve, the plunger is mechanically connected to the seal assembly and forms a force-transmitting unit. The solenoid, which acts directly on the plunger, actuates the sealing element on the underside of the plunger directly. The valve's operation is not affected by the pipe pressure or the flow rate, and the valve functions from zero to a maximum permitted rated pressure.	<ul style="list-style-type: none"> • Only small nominal sizes – low flows in pipes • High pressures • Liquid and gaseous media as detailed in the specifications • Switches without a differential pressure • Used under coarse vacuum

Pilot-operated valve	
Description	Intrinsic features
This valve has a pilot valve and a throttle bore. It uses the pipe pressure in order to function. When the solenoid is energised, the pilot valve opens and the pressure on the valve piston or the diaphragm on the exit side of the valve reduces. The resulting pressure difference causes the pipe pressure to raise the piston or the diaphragm from the valve seat and the valve opens. When the solenoid is de-energised, the pilot valve opening closes and the pipe pressure is able to build up again through the orifice on the piston or diaphragm, and the required force is applied to close the valve.	<ul style="list-style-type: none"> • Larger nominal sizes • Higher pressures can be switched with relatively small magnetic forces • Liquid and gaseous media as detailed in the specifications • Switching is possible only at the minimum pilot pressure (see the "Minimum pressure" given in the catalogue) • For larger nominal sizes, the switchable pressures reduce (see the "Highest pressure" given in the catalogue)

Force pilot-operated valve	
Description	Intrinsic features
This form of actuation combines the advantages of servo-assistance with the principle of direct actuation. With force pilot-operated valves, the plunger and seal are mechanically connected. The opening process can begin without a pressure difference. As this process of movement continues, the pilot pressure supports the opening process through the additional pilot bore. The valve works from 0 bar to the maximum permissible pressure.	<ul style="list-style-type: none"> • Larger nominal sizes • Switching is possible without a minimum pilot pressure • Liquid and gaseous media as detailed in the specifications • For larger nominal sizes, the switchable pressures reduce (see the "Highest pressure" given in the catalogue)

CYLINDER FORCES

Cylinder forces in double-acting cylinders:

Pressure/force tables

Piston force [daN]; 1 daN (10N) = approx. 1 kg

Ø Piston [mm]	Ø Rod [mm]	Piston area [cm ²]		Pilot pressure [bar]															
				2		3		4		5		6		7		8			
		Push	Pull	Push	Pull	Push	Pull	Push	Pull	Push	Pull	Push	Pull	Push	Pull	Push	Pull		
8	4	0.5	0.38	1	0.8	1.5	1.1	2	1.5	2.5	1.9	3	2.3	3.5	2.6	4	3		
10	4	0.79	0.66	1.6	1.3	2.4	2	3.1	2.6	3.9	3.3	4.7	4	5.5	4.6	6.3	5.3		
12	6	1.13	0.85	2.3	1.7	3.4	2.5	4.5	3.4	5.7	4.2	6.8	5.1	7.9	5.9	9	6.8		
16	6	2.01	1.73	4	3.5	6	5.2	8	6.9	10.1	8.6	12.1	10.4	14.1	12.1	16.1	13.8		
16	8	2.01	1.51	4	3	6	4.5	8	6	10.1	7.5	12.1	9	14.1	10.6	16.1	12.1		
20	8	3.14	2.64	6.3	5.3	9.4	7.9	12.6	10.6	15.7	13.2	18.8	15.8	22	18.5	25.1	21.1		
20	10	3.14	2.36	6.3	4.7	9.4	7.1	12.6	9.4	15.7	11.8	18.8	14.1	22	16.5	25.1	18.8		
25	8	4.91	4.41	9.8	8.8	14.7	13.2	19.6	17.6	24.5	22	29.5	26.4	34.4	30.8	39.3	35.2		
25	10	4.91	4.12	9.8	8.2	14.7	12.4	19.6	16.5	24.5	20.6	29.5	24.7	34.4	28.9	39.3	33		
32	12	8.04	6.91	16.1	13.8	24.1	20.7	32.2	27.6	40.2	34.6	48.3	41.5	56.3	48.4	64.3	55.3		
40	12	12.57	11.44	25.1	22.9	37.7	34.3	50.3	45.7	62.8	57.2	75.4	68.6	88	80	100.5	91.5		
40	16	12.57	10.56	25.1	21.1	37.7	31.7	50.3	42.2	62.8	52.8	75.4	63.3	88	73.9	100.5	84.4		
50	16	19.63	17.62	39.3	35.2	58.9	52.9	78.5	70.5	98.2	88.1	117.8	105.7	137.4	123.4	157.1	141		
50	20	19.63	16.49	39.9	33	58.9	49.5	78.5	66	98.2	82.5	117.8	99	137.4	115.5	157.1	131.9		
63	16	31.17	29.16	62.3	58.3	93.5	87.5	124.7	116.6	155.9	145.8	187	175	218.2	204.1	249.4	233.3		
63	20	31.17	28.03	62.3	56.1	93.5	84.1	124.7	112.1	155.9	140.2	187	168.2	218.2	196.2	249.4	224.2		
80	20	50.27	47.12	100.5	94.2	150.8	141.4	201.1	188.5	251.3	235.6	301.6	282.7	351.9	329.9	402.1	377		
80	25	50.27	45.36	100.5	90.7	150.8	136.1	201.1	181.4	251.3	226.8	301.6	272.1	351.9	317.5	402.1	362.9		
100	25	78.54	73.63	157.1	147.3	235.6	220.9	314.2	294.5	392.7	368.2	471.2	441.8	549.8	515.4	628.3	589		
125	32	122.72	114.68	245.4	229.4	368.2	344	490.9	458.7	613.6	573.4	736.3	688.1	859	802.7	981.7	917.4		
160	40	201.06	188.5	402.1	377	603.2	565.5	804.2	754	1005	942.5	1206	1131	1407	1320	1609	1508		
200	40	314.06	301.59	628.3	603.2	942.5	904.8	1257	1206	1571	1508	1885	1810	2199	2111	2513	2413		

Cylinder forces in single-acting cylinders:

Single-acting short stroke cylinder			
Diameter [mm]	Block force of spring N	Max. stroke [mm]	Force with destressed spring N
12	6	25	1.5
16	7	25	3
20	12	25	4
25	14	25	5
32	33	50	6
40	45	50	15
50	70	50	20
63	81	50	25

Single-acting cylinder in accordance with ISO L76432			
Diameter [mm]	Block force of spring N	Max. stroke [mm]	Force with destressed spring N
8	3	50	1
10	5	50	1
12	7	50	3
16	20	50	5
20	22	50	12
25	28	50	17

COMPRESSED AIR PIPEWORK SYSTEM

IMPORTANT INSTALLATION INSTRUCTIONS

If the system has vertical branch pipes along a wall, it is advisable first to attach the wall brackets only on the pipes running horizontally and then pressurise the installation.

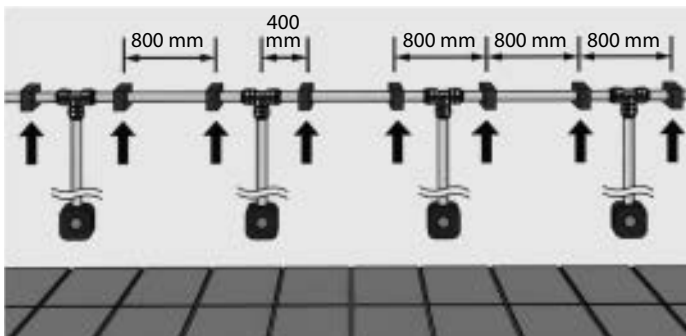

Phase 1: System not under pressure

After this, the other wall brackets and the pressurised air points of use (air distribution box) can be fastened in place.

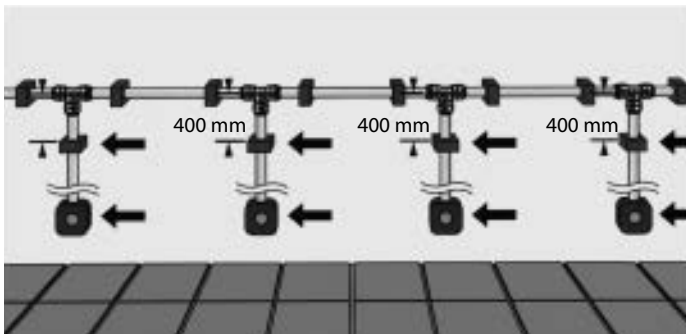

Phase 2: Fastening in place of the pipes under pressure

If the pipework extends over a long distance, it is recommended that an expansion bend be provided every 25 metres. Placement around a column requires an adequate distance between the wall and the distribution pipework. This is likewise resolved by installing an expansion bend.

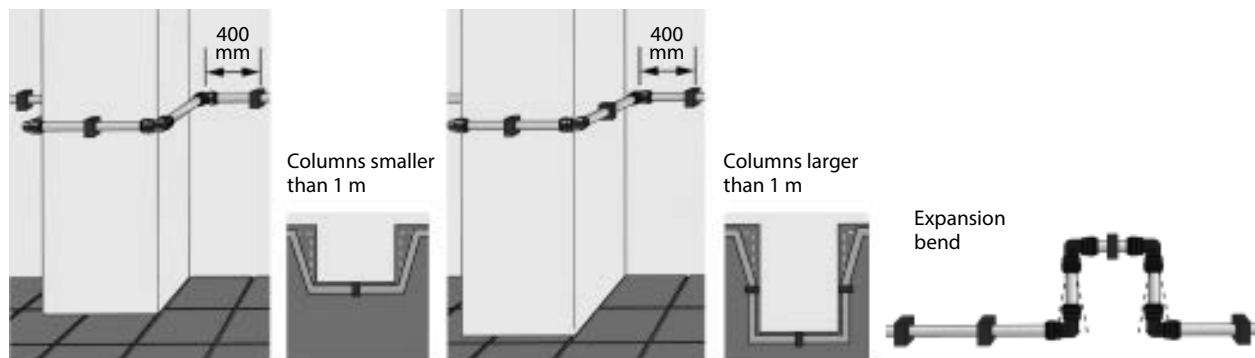

Compressed air pipelines should always incorporate a water separator (swan neck bend).

IMPORTANT INSTALLATION INSTRUCTIONS

The user-friendly design of the compressed air pipework system allows it to be installed or removed without any tools at all. As well as the time saved, this can also result in up to 50 % cost savings.

The following points should be observed to ensure a safe and trouble-free installation:

- The pipe clamps must be fitted in such a way that there is still enough play to allow the pipe to be displaced.
- To avoid damage to the O-rings in the connectors, it is also important to check that the pipe ends are free of burrs.
- We always recommend chamfering the pipes to reduce the insertion forces.
- To ensure the pipe ends meet at the best angle (90°), they should always be cut using a pipe-cutter.
- To prevent pressure losses in the system, the installer must ensure that the pipes are fully inserted into the connectors (look for the marking on the connector).
- We recommend keeping the pipework about 30 mm from the wall where the compressed air pipework system passes around a column to allow for the extension in length of the pipes and connectors.
- For installations with several vertical pipes, we recommend that the pipe clamps on the horizontal pipework are fitted first, then the system be placed under pressure. Only then should the vertical pipe clamps and connectors be installed. This ensures that the vertical pipes will remain vertical after the installation is complete.
- If the compressed air system does not incorporate an air dryer, we recommend the use of our T connector with an integrated water separator. This allows the condensate to be collected at a specific point.

CALCULATION OF THE LONGITUDINAL EXPANSION OF POLYAMIDE PIPES*

To avoid any undesirable bending of pipes and connections, an accurate calculation of thermal expansion of the compressed air pipework must be performed before the system is installed.

The plastic pipes change in length by approx. 0.2 mm/°C per metre.

The following factors relating to the longitudinal expansion of polyamide pipes must be taken into account:

	Factor
PA-12 pipe (soft)	1.5
PA-12 pipe (medium)	1.3
PA-12 pipe (hard)	1.0

Specific coefficient of longitudinal expansion of polyamide = $10^{-4}/^{\circ}\text{C}$

The following formula must be used to calculate the longitudinal expansion:

$$\begin{aligned} & \text{Factor (PA pipe)} \\ & \times \text{ specific coefficient of longitudinal expansion (} 10^{-4}/^{\circ}\text{C)} \\ & \times \text{ pipe length (L)} \\ & \times \text{ temperature difference (T)} \\ & = \text{ change in length L} \end{aligned}$$

Example calculation:

A 150 metre long compressed air pipe (hard polyamide pipe) installed in a factory building in which the ambient temperature varies between +15 °C to + 40 °C (T is therefore +25 °C) expands as follows:

$$\text{Change in length L} = 1.0 \times 10^{-4}/^{\circ}\text{C} \times 150 \text{ m} \times 25 \text{ }^{\circ}\text{C}$$

$$\text{Change in length L} = 0.375 \text{ m}$$

* The examples and tables given here are intended for information only and do not replace the design of a compressed air system by an appropriately qualified engineer.

EXAMPLE OF A PIPEWORK CALCULATION *

COMPRESSED AIR DISTRIBUTION SYSTEM WITH RING MAIN

The calculation for the ring main is based on half the nominal length of the complete pipework system and the full compressed air requirement. For example: compressed air requirement 1000 l/min, operating pressure 7 bar, complete pipework length would be 300 m as a ring main, therefore the length for calculation purposes would be 150 m.

COMPRESSED AIR DISTRIBUTION SYSTEM WITH BRANCH PIPE

The calculation for the branch pipe is based on the full nominal length of the complete pipework system and the full compressed air requirement. For example: compressed air requirement 750 l/min, operating pressure 7 bar, and the complete pipework length would be 50 m.

* The examples and tables given here are intended for information only and do not replace the design of a compressed air system by an appropriately qualified engineer.

A = pipe length of the ring main in m
 B = delivery capacity of the compressor in l/min

A \ B	25	50	100	150	200	250	300
200	12	12	12	15	15	15	18
400	12	12	15	15	15	18	18
500	15	15	15	18	18	18	18
750	15	15	18	18	18	22	22
1000	15	15	18	18	22	22	22
1500	18	18	18	22	22	22	22
2000	18	18	22	22	22	28	28
3000	22	22	28	28	28	28	28
4000	28	28	28	28	28	28	28

In calculating the lengths of pipe required for the main, supply and branch pipework, we recommend that the supply system is designed as a ring main. This allows the sizes to be calculated based on only half the quantity of air delivered and half the pipework length.

EQUIVALENT PIPEWORK LENGTH OF FITTINGS (PER ITEM)

ØE in mm	12	15	18	22	28
ØI in mm	9	12	14	18	23
Elbow	0.6 m	0.7 m	1.0 m	1.3 m	1.5 m
T piece	0.7 m	0.85 m	1.0 m	1.5 m	2.0 m
Reducer piece	0.3 m	0.4 m	0.45 m	0.5 m	0.6 m

These values must be added to the actual pipe lengths to arrive at the length in terms of hydraulic flowL.

FLOW RATES FOR PA AND ALUMINIUM PIPES

Pipe Ø in mm	PA pipe	PA pipe	Aluminium pipe	Aluminium pipe
	Main pipe	Branch pipe	Main pipe	Branch pipe
	6 m/sec. at 8 bar in l/min	15 m/sec. at 8 bar in l/min	6 m/sec. at 8 bar in l/min	15 m/sec. at 8 bar in l/min
12	205	515	–	–
15	365	916	430	1004
18	498	1248	650	1548
22	823	2057	1018	2442
28	1344	3367	1720	4160

The values given for the flow in the main pipe can be changed for flow in each direction.

NOISE TABLE FOR SAFTEY NOZZLES

COMPARED TO STANDARD ONE-HOLE TYPES

T

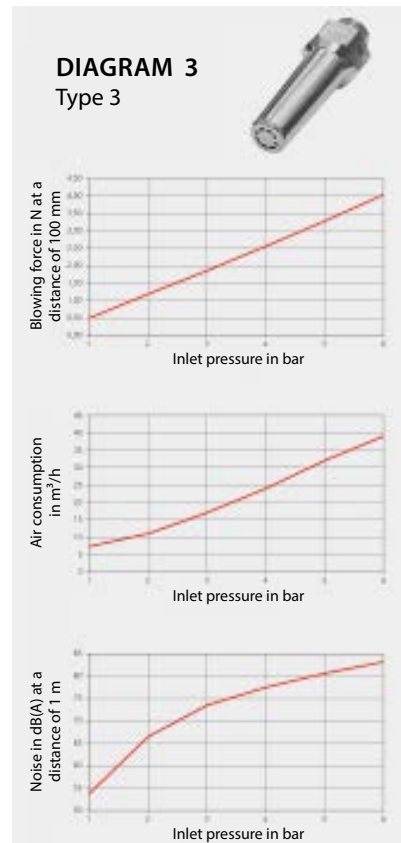
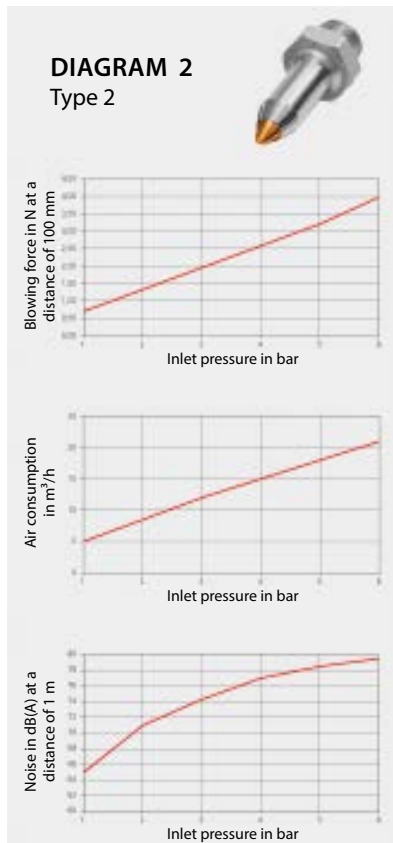
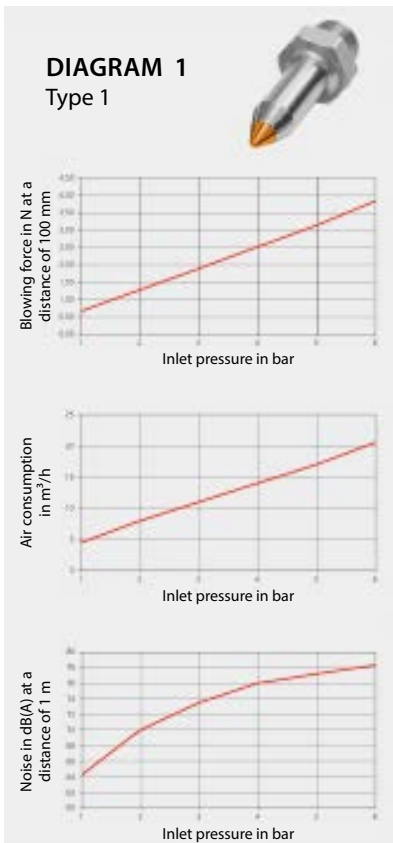
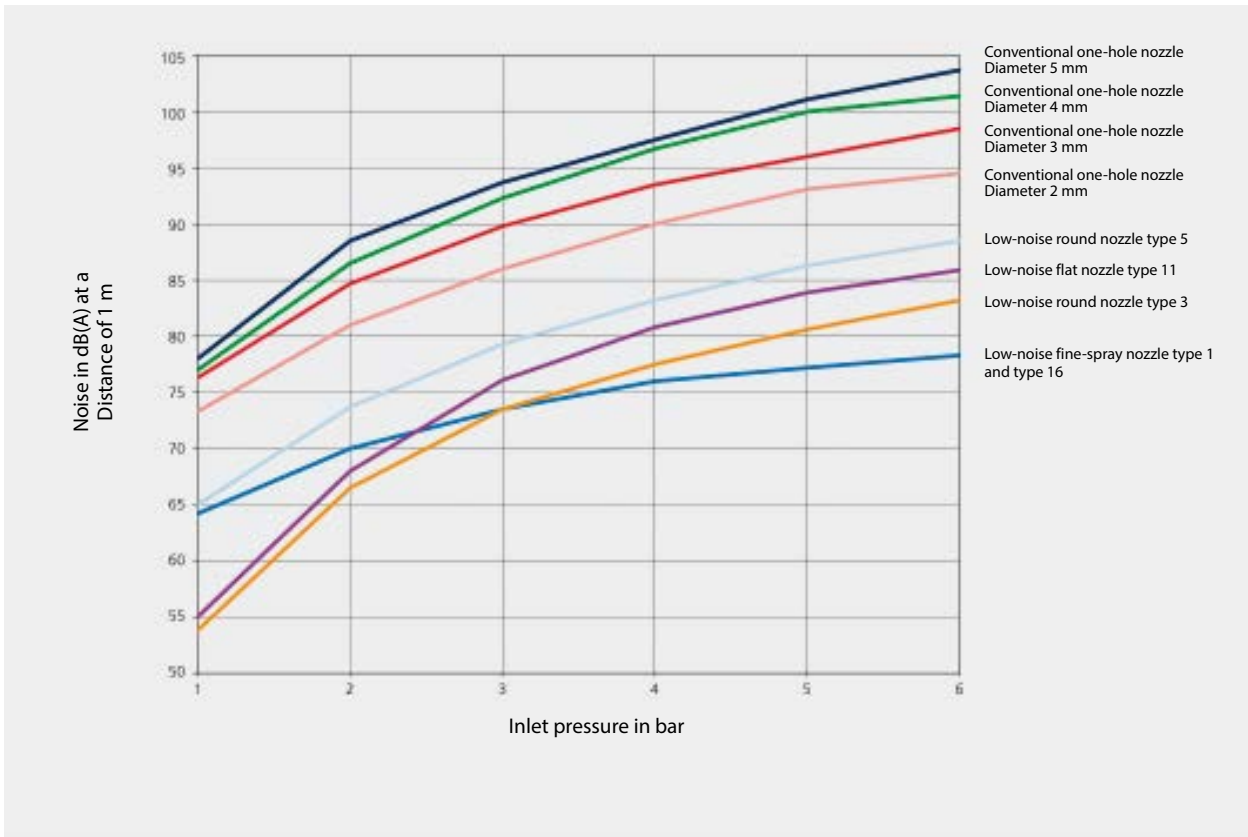

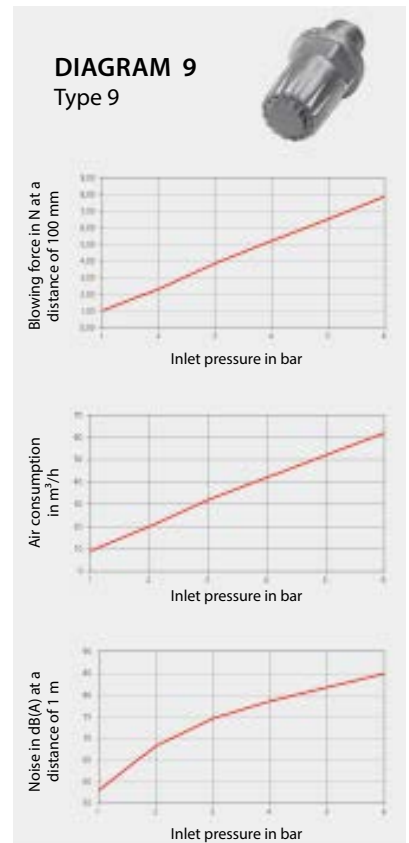
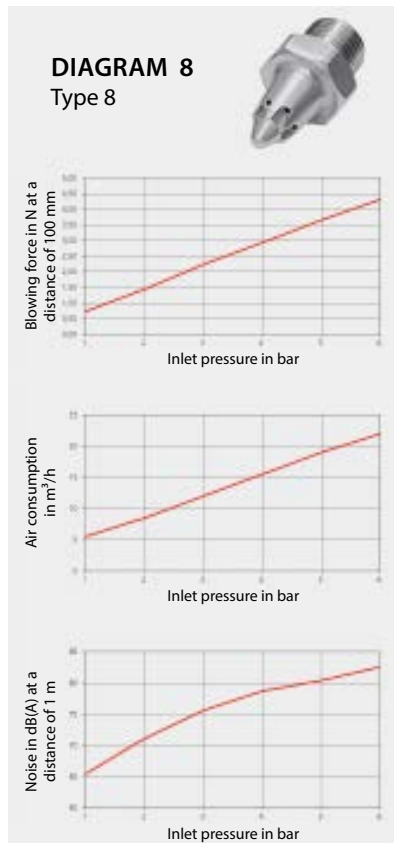
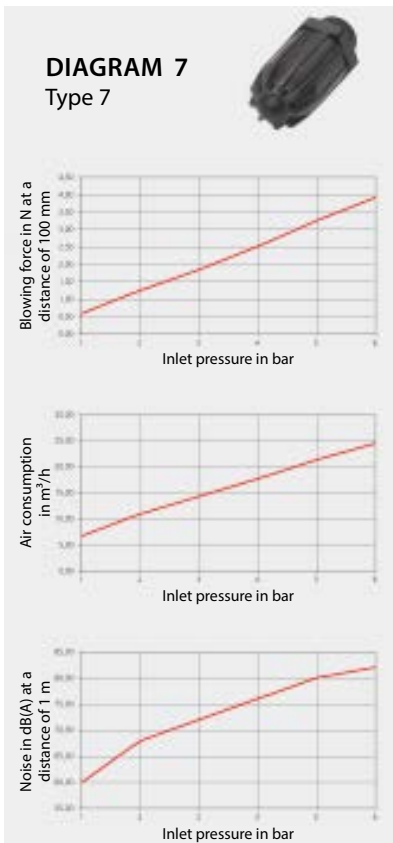
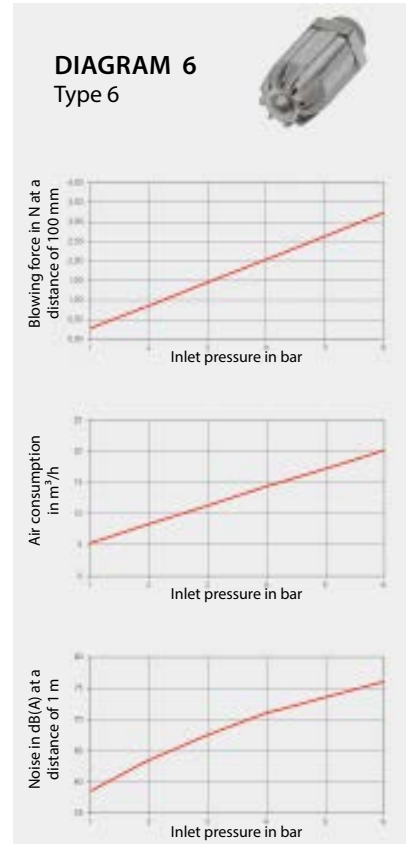
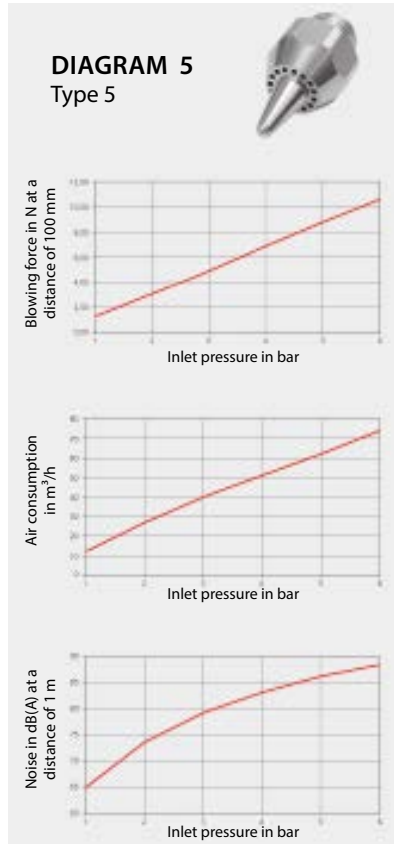
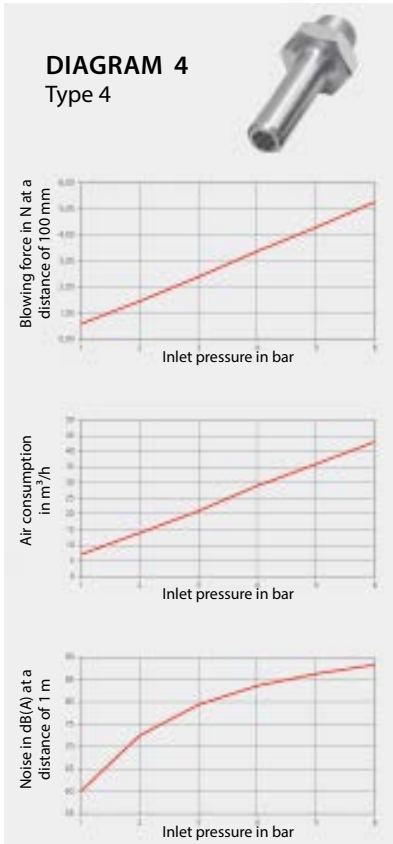

T

DIAGRAM 10
Type 10

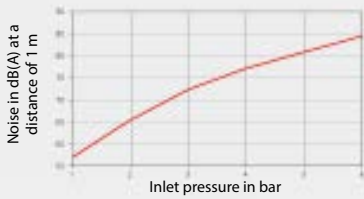
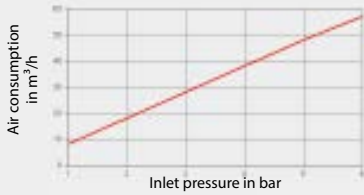
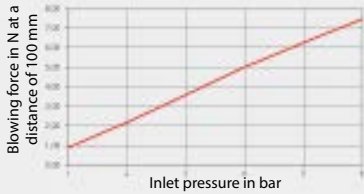

DIAGRAM 11
Type 11

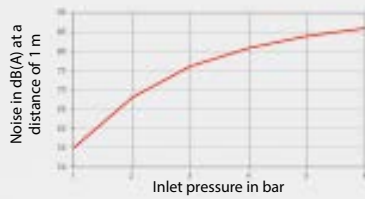
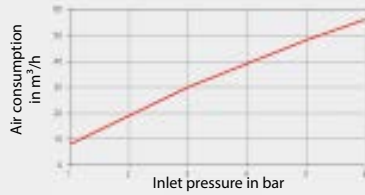
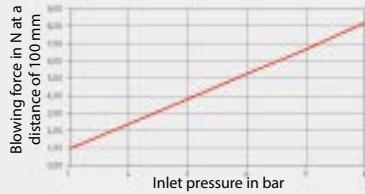

DIAGRAM 12
Type 12

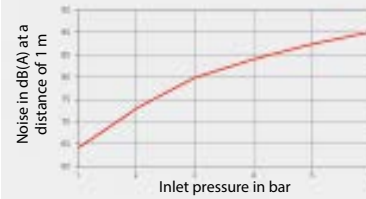
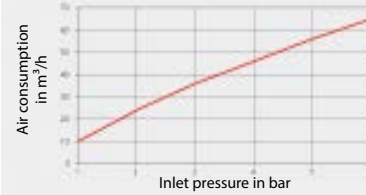
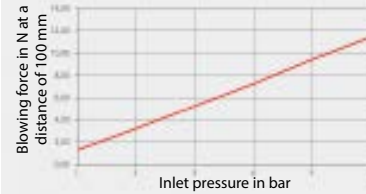

DIAGRAM 13
Type 13

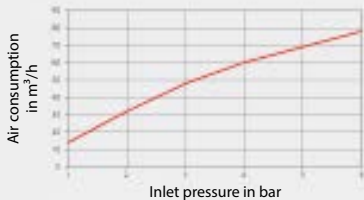
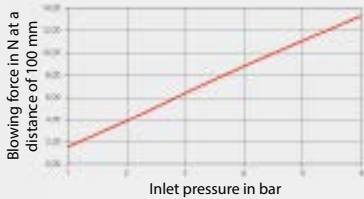

DIAGRAM 14
Type 14

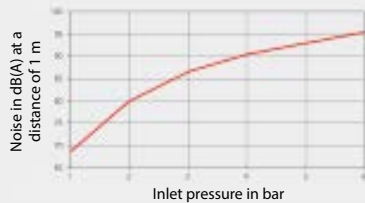
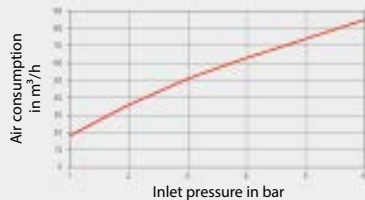
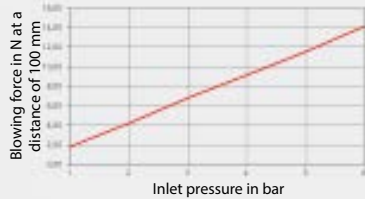

DIAGRAM 15
Type 15

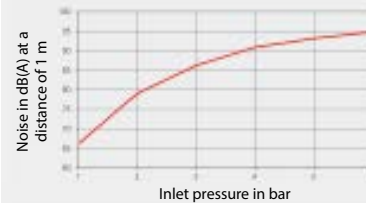
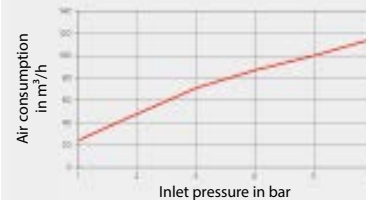
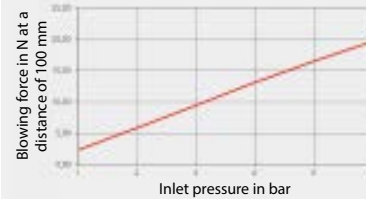

DIAGRAM 16
Type 16

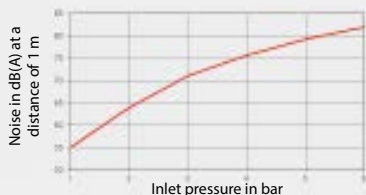
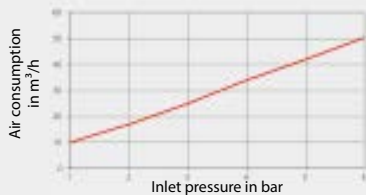
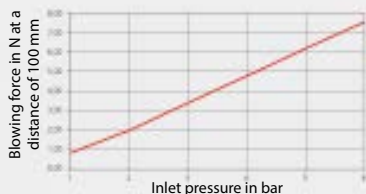

DIAGRAM 17
Type 17

